

LawnMaster

Lawn Genie

Three-Program Hybrid Controller

LM-6 LM-9 LM-12

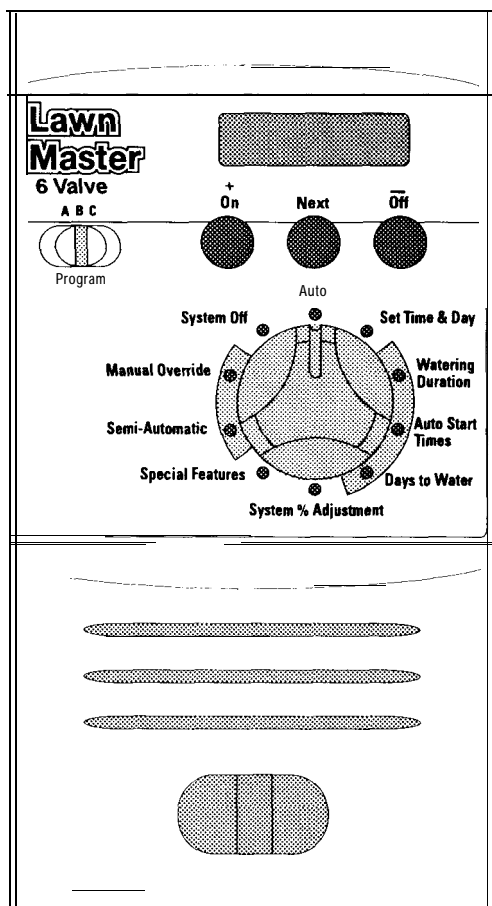

OPERATOR'S MANUAL



James Hardie
Irrigation

TABLE OF CONTENTS

Before You Begin

Introduction	1
Special Features	1

Installation

Installation	2
Wiring Valves	2
Connecting Wires To Controller..	3
Installing Battery	3
Transformer Connection	3

Getting Started

Default Program	4
Erase Program	4
Setting Time & Day	4
Programs..	5
Sample Watering Plan	5
Auto Programming	5
Auto Start Time	6
Setting Days To Water..	6
To Review	7
Other Dial Functions	7
Special Features	7

Manual Operation

Semi-Automatic Operation	8
Manual Override..	8
System Off	8
Sensor Override	8

Additional Information

Troubleshooting	9
Back-Up Protection	10
Warranty..	10

Thank you for purchasing the
LAWN MASTER from Hardie Irrigation.

SPECIAL FEATURES

Convenient Operation

Full Automatic, Semi-Automatic or Manual operation for controlling any watering need.

Landscape Saver

The unique ELECTRONIC CIRCUIT BREAKER in LAWN MASTER will check for valve failure. If a short is detected the controller will display SHORT and override that valve while continuing to water the remaining valves.

Program Saver

Advanced microprocessor electronics for protecting program memory will keep the program during power failures, even when there is no battery back-up.

Circuit Saver

Circuit protection from surge and other transient situations.

Power Saver

Ultra low power use during operation also provides extended life during back-up battery operation. The 9V battery will keep time accurately for up to 60 days without main power source. Battery will last between 2-4 years under normal conditions.

Water Saver

The system % Adjustment feature lets you simply adjust watering duration for temporary seasonal adjustments.

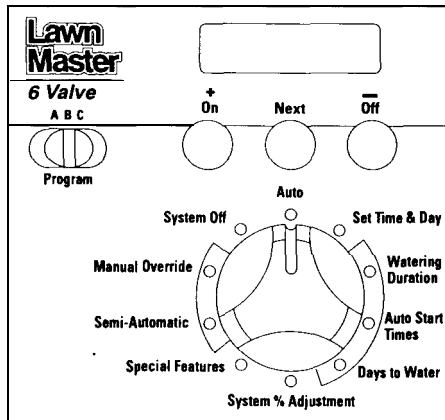

INSTALLATION

Note: **LAWN MASTER** is for indoor installation only. Do not plug transformer into the same outlet as other high power devices such as garage door opener, power tools, etc.

1. Select an indoor location near a 110 volt outlet to mount your controller. Avoid using an outlet that is controlled with an on/off switch. Mount approximately 48" from floor.
2. Controller should not be exposed to water or operated at temperatures below 14 deg. or above 113 deg. Fahrenheit.
3. Screw a No. 8 screw into wall leaving approximately 1/8" exposed. Use a plastic anchor sleeve if wall is plaster board or masonry.
4. Slip the keyhole in the back of the controller over the exposed screw.
5. Screw No. 8 screws through the holes at the bottom of the controller case to secure.

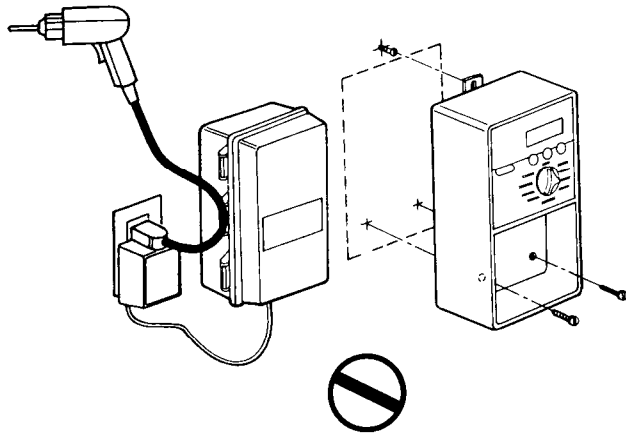

WIRING THE VALVES

Connect your valves to the controller with 20 gauge plastic jacketed wire. If distance from controller to valves is longer than 700 feet use 16 gauge.

Thermostat wire is available in 4 and 7 strand colored wires. You may bury wire in the ground being careful to avoid locations which can be disturbed by digging. Use of UF wire is recommended for underground wiring.

Extra protection is possible by pulling the wires through PVC water pipe. All wire connections should be made using water-proof connectors.

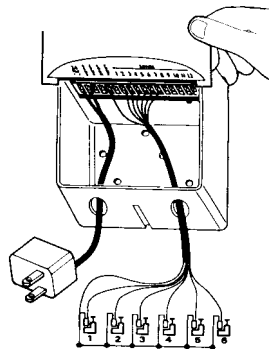

CONNECTING THE WIRES TO THE CONTROLLER

- .Remove lower panel covering, turn up and over. Line up terminal identification area with terminal screws as shown below.
- .Connect the wire from valve number 1 to terminal slot number 1, connect the wire from valve number 2 to terminal slot number 2 and so on until all valves are connected. Connect the COMMON wire from the valves to the terminal marked COMM.
- .If using a MASTER VALVE or PUMP START, see below.
 - Back side of lower panel
 - Terminal identification area
 - Terminals

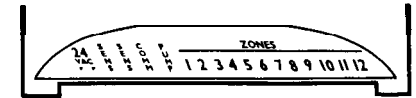

Master Valve Pump Start Hook-Up

In cases where a pump is to be controlled by the Master Valve output, DO NOT drive the pump directly from the controller. The Master Valve Terminal must be connected to the coil of a 24 VAC relay. (Lawn Genie Pump Relays are relay part no. L30000W)

The pump latch relay should be set up by an electrician so that a switch closure will activate the latch relay coil, turning on the pump. The switch contacts of the relay should be connected to control the latch relay coil, see figure. The relay should be mounted at least 5 feet from the controller, and the box must be grounded.

Installation must follow all local electrical wiring codes.

Make sure master valve is selected as needed in all your programs. Refer to watering duration (page 5)

Caution: Do not attempt to power the controller using power from one phase of pump power. This will damage the controller, the pump or both.

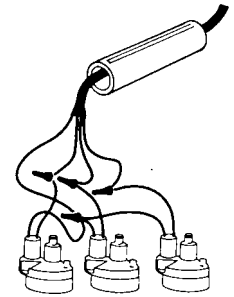

INSTALL BATTERY

LAWN MASTER is protected from time loss with a back-up battery (install the battery after the transformer is connected.) Battery will maintain time and day up to 60 days during a power failure. Install 9 volt alkaline battery as shown. (Battery not included).

Note: Battery will not operate valves during a power outage.

TRANSFORMER CONNECTION

Make sure transformer is disconnected from power outlet. Connect the two lead wires from the transformer to terminals as shown.

- .First (2) terminal locations: 24 VAC
- .Plug- in transformer, check operation.

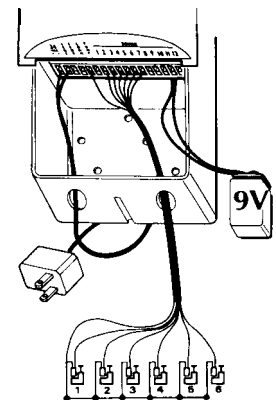

PROGRAMMING YOUR LAWNMASTER CONTROLLER

DEFAULT PROGRAM

When new from the factory: A default program has been installed in PROGRAM A for your convenience. This program is set to water all valves for 10 minutes every day at 4:00 AM.

If this program works for your system simply set the time and day and you are finished. However, if you would like to customize your LAWN MASTER with your own unique programs, erase this default program by following the simple steps provided below.

VALVE 01

10 MIN

ERASE PROGRAMMED INFORMATION

- . Set the dial to Special Features
 - . Press the Next button until "Erase" is displayed
 - . Press + button display will show "Confirm"
 - . Press + button again, display will show "Done"
- You may now program LAWN MASTER with custom programs using the instructions on the following pages.

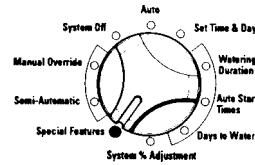

ERASE

SET CLOCK TIME & DAY

-Set the dial to "SET TIME & DAY"

HOUR The hour will flash on the display
Push the + or - button to change "HOUR"

MINUTES Push the NEXT button to go to "MINUTES"
Push the + or - button to change "MINUTES"

AM/PM Push the NEXT button to go to the "AM/PM" function
Push the + or - button to select choice

MONTH Push the NEXT button, display will show "DATE"
The month will be flashing
Push the + or - button to change "MONTH"

DAY Push the NEXT button to go to "DAY"
Push the + or - to change "DAY"

YEAR Push the NEXT button to go to "YEAR"
Push the + or - to change "YEAR"

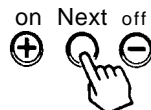
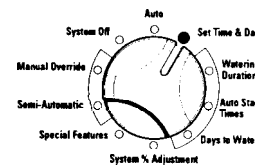

PROGRAMS

Lawn Master provides 3 different PROGRAMS to allow custom watering of your landscaping.

All three programs will run, regardless of Program Switch position.

Be careful not to "over program" or accidentally start watering everything at the same time. You may not have enough water pressure to operate more than one zone at a time.

Do a little planning before you start, refer to our sample watering plan below using your own landscape and lay-out your "optimum watering plan" based on your plant's needs. Your local nursery is an excellent source of information.

When you finish programming, write out your "watering plan" or programs on the back of your instruction envelope located inside your controller door.

Each program turns on each valve in sequence, one after the other, starting at your programmed start time, on the days you have selected and ends when the last valve with watering duration is finished.

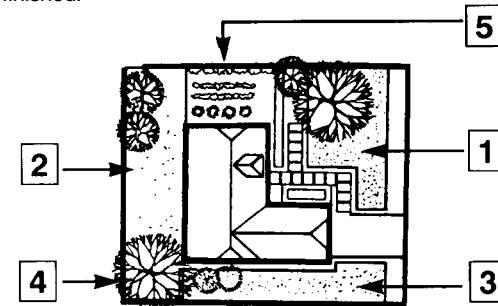

SAMPLE WATERING PLAN

<u>PROGRAM</u>	<u>VALVE</u>	<u>DESCRIPTION</u>	<u>WATER DURATION</u>	<u>START</u>	<u>DAYS</u>
A	1	Front lawn	15 min.	5:00AM	Odd
	2	Back yard	15 min.		
	3	Side yard	10 min.		
B	4	Trees drip	2 hrs.	5:00PM	Mon
C	5	Garden	5 min.	4:00AM 7:00AM	Everyday

AUTO PROGRAMMING

1. Select Program: A, B, or C
2. Each PROGRAM selected must follow these steps:

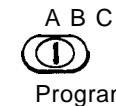

Watering Duration

1. This sets the amount of TIME each valve will be ON.

To set:

- . Turn the DIAL to "WATERING DURATION", display will show "Valve 1", then "Off".
- . Push the +button to set desired time.
- . Push the - button to set valve off.
- . Push the NEXT button to set next valve and repeat steps until all valves are set.

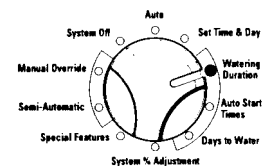

VALVE 01

Master Valve

A master valve or pump start is sometimes used in systems. When selected ON the controller provides constant output to that terminal when valves are on. See MASTER VALVE HOOK-UP. (page 6) The LAWN MASTER allows you to select this option on each program. The default is OFF for all programs.

- To select your master valve ON:
 - Press NEXT until MASTER is displayed (after last valve)
 - Push ON to activate, push OFF to turn OFF.

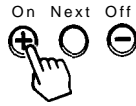

AUTO START TIME

This sets the TIME OF DAY you wish to water. Each start time will start a cycle running each valve, one at a time, for their programmed watering duration, starting with the first valve and continuing until the last valve has completed its watering.

- To set
- Turn the dial to "AUTO START TIMES". The display will show "START A1"
 - To set the desired time push + button until desired time is displayed. Pushing the - button will CANCEL that start time.

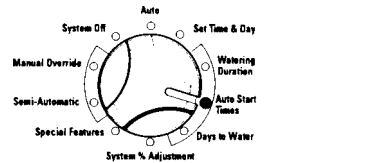

OTHER START TIMES

- To water more than once a day:
- Press NEXT to set a second or third START TIME.
 - Repeat the above steps for each START TIME.

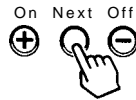

DAYS TO WATER

This sets the DAYS of the week you wish to water. There are 4 options you may use for convenience. Push NEXT repeatedly to display options; press NEXT to select the one that you prefer.

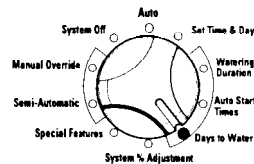

1. ODD-This option will water only ODD days of the month. Automatically skips the 31st day of the month. Push ON to select



2. EVEN-This option will water only EVEN days of the month.

Push ON to select.

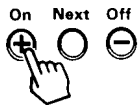

JULY						
S	M	T	W	T	F	S
						①
2	③	4	⑤	6	⑦	8
⑨	10	⑪	12	⑬	14	⑮
16	⑰	18	⑱	20	21	22
23	24	25	26	27	28	29
30	③					

3. SKIP-You may select an interval from 1- 30 days to water. For example, to water once every 10 days push the + button until display shows 10. (This option does not relate to the days of the month or week)
4. DAYS OF THE WEEK-Push ON to activate "DAYS", push NEXT to sequence through the individual days. Use the + button to select the day. Use the - button to eliminate that day.

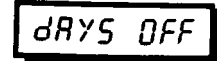
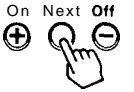

Your programming is now completed for PROGRAM A. If you wish to use your other programs move PROGRAM switch to position B or C and repeat the programming steps starting on page 8. Now return to the Auto Position. During operation B, all running valves will scroll on the display.

REVIEW

- To REVIEW your entire program:
- Set dial to "SPECIAL FEATURES", select "PROGRAM", display will show "Review".
 - Push the + button, display will scroll all programmed information.



OTHER DIAL FUNCTIONS

SYSTEM % ADJUSTMENT: Dial in this position for simple seasonal adjustment of all your valve's watering duration, When weather conditions return to normal this adjustment can be returned to normal (100%). This change will not permanently change your original programs.

- To use
- Select the PROGRAM you wish to adjust.
 - Set the dial to "SYSTEM % ADJUSTMENT". This indicates all valves will water at 100% of their watering duration.
 - Use the + or - button to adjust, the display will show selected change.
 - After adjusting return the dial to "AUTO".

Note: Below 100% for less watering. Above 100% for more watering. 00% is off.

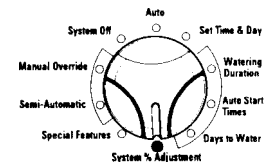

SPECIAL FEATURES

This position has three functions. In this position you may erase all programmed information (page 4), review all programmed information (page 7), or set your sensor (page 8).

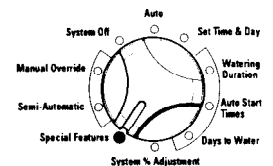

MANUAL OPERATION

SEMI-AUTOMATIC

This position will let you water your normal program cycle at any time. Each valve's WATER DURATION will be operated for the program selected.

- Set dial to "SEMI AUTOMATIC"
- Push ON to start watering.
- Push OFF to stop watering.
- Push NEXT to advance to the next valve.
- Return the dial to "AUTO" after watering cycle begins.
(The display will periodically show remaining time on the operating valve.)

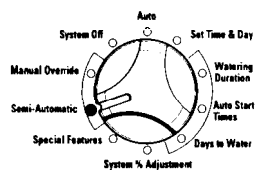

MANUAL OVERRIDE

This position will allow you to water any individual valve or valves for a specific time. If you are using a master valve, you can activate for manual override.

- Push the NEXT button to select the valve you wish to water
- Push the + **button** to set the time you wish to water, the display will show your time.
- Push the NEXT button to select the next valve you wish to water.
- Push the + **button** to set time, repeat setting until all valves are set.
- Push the - **button** to cancel any valves you do not wish to water

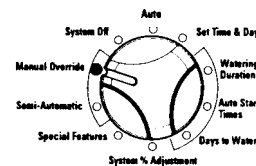

If using a master valve or pump, press NEXT until "master" is displayed (after last valve) press the + **button**. The master is now on while your valves are watering.

SYSTEM OFF

This position will allow shut down of all water programs. (allow 10 seconds to turn-off). For immediate shut down, turn to "SYSTEM OFF" and push OFF button.



SENSOR OVERRIDE

Rain switches or moisture sensors are often used in automatic irrigation systems to not allow automatic watering during rainy or wet conditions.

The **Lawn Master** provides convenient, sensor hook-up terminals and an override or bypass option. The override option (OFF) lets you simply bypass the sensor for testing. If you are not using a sensor, setting should be "OFF".

- Set dial to "SPECIAL FEATURES"
- Push NEXT twice, display will show "Sensor N"
- Push OFF to override. If not using a RAIN SENSOR, setting should be "OFF".
- Push ON to activate the RAIN SENSOR. Once installed the RAIN SENSOR will override your programs.

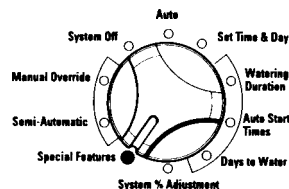

TROUBLESHOOTING

PROBLEM	CORRECTION
1. All valves do not turn on automatically	1 Verify program 2 Check valve common wire for proper hook-up 3 Check for shorted valve, refer to "Controller Displays SHORT"
2. Cannot Program	Remove battery [check voltage]. Disconnect power to controller for 1 min. Reconnect power and reprogram. Reconnect good 9v alkaline battery.
3. Controller Skips a Cycle	Verify start times, time and water days
4. No Display	Remove battery [check voltage] Disconnect power to controller for 1 min. Reconnect power and reprogram. Reconnect good 9V alkaline battery.
5. Valve Stays On	1 Verify watering duration. 2 Disconnect valve; check for manual bleed closure. 3 Disconnect wire to valve. If still on, valve is bad. 4 Check for manual mode; place controller in SYSTEM OFF 5 Check solenoids for obstructions or wiring shorts. 6 Check valve for rocks or other obstructions or torn or damaged diaphragm.
6. Valve will not turn on	1. Verify start times, time and water days. 2. Make sure dial is not in SYSTEM OFF 3. Verify program, Review program (page x) 4. Make sure common wire and valve wire are connected. 5. Check solenoid and valve bleed tube. 6. Check for shorted valve; refer to "Controller Displays SHORT" 7. Check RAIN SENSOR status (page 8). set to OFF
7. Controller Displays SHORT	1. Note valve number flashing. 2. Examine wiring connections for breaks or bad connections. Repair and reconnect. 3. Examine solenoid for shorted connections. Repair and reconnect. 4. Make sure solenoid rating does not exceed capacity of controller. 5. To reset, set dial to AUTO or press any button.

BACK-UP PROTECTION

Lawn Master has been designed to insure operation of the controller in the event of unexpected electrical disturbances, power loss, or valve failure.

MEMORY PROTECTION

Your programs are stored in a unique electronic device called "Non-Volatile Memory". This protects your programs from being lost when electrical power is disturbed even without connecting a battery.

CIRCUIT PROTECTION

Lawn Master electronics are protected from electrical disturbances such as large transient voltages and static discharge.

ELECTRONIC FUSE

Lawn Master is protected with an electronic circuit breaker. If the electronics detect a short circuit at one of the valves, that valve will be shut off automatically. The display will show 'SHORT'. The controller will continue operating the remaining valves as programmed. After you repair the valve set dial to "AUTO".

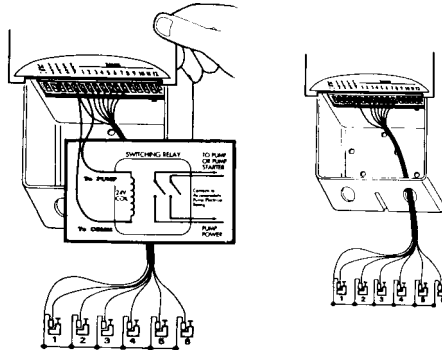

WARRANTY

Limited Warranty: Hardie Irrigation warrants to its customers that **Lawn Master** be free from defects in materials and workmanship for a period of three years from date of purchase. We will replace, free of charge, the defective part or parts found to be defective under normal use and service for a period of three years after purchase, proof of purchase required.

We reserve the right to inspect the defective part prior to replacement. Hardie Irrigation will not be responsible for consequential or incidental cost or damages caused by product failure.

For additional assistance, call our Customer Service Hot-line at 1-800-231-5117.

This equipment has been tested and found to comply with the limits for a class B digital device, pursuant to Part 15 of the FCC Rules. These limits are designed to provide reasonable protection against harmful interference in a residential installation. This equipment generates, uses and can radiate radio frequency energy and if not installed and used in accordance with the instructions, may cause harmful interference to radio communications. However, there is no guarantee that interference will not occur in a particular installation. If this equipment does cause harmful interference to radio or television reception, which can be determined by turning the equipment off and on, the user is encouraged to try to correct the interference by one or more of the following measures:

- Reorient or relocate the receiving antenna.
- Increase the separation between the equipment and receiver.
- Connect the equipment into an outlet on a circuit different from that to which the receiver is connected.
- Consult the dealer or an experienced radio/TV technician for help.

This equipment has been verified to comply with the limits for a class B computing device, pursuant to FCC Rules. In order to maintain compliance with FCC regulations, shielded cables must be used with this equipment. Operation with non-approved equipment or shielded cables is likely to result in interference to radio and TV reception. The user is cautioned that changes and modifications made to the equipment without the approval of manufacturer could void the user's authority to operate this equipment.



A James Hardie Product

**Product Inquiries and Repairs
1 - 800- 231- 5117**

**Part No. 769301
01994 James Hardie**